





SKU: AP5405

-  VOLT Pneumatic Pressure Regulator
-  VOLT pneumatische Druckregler
-  VOLT regulador de presión neumática
-  VOLT pneumatique Régulateur de pression

Valves[™]
O N L I N E

- 1/8 " - 1" Pneumatic Regulator Supplied with Gauge and Bracket.
- 1/8 " - 1" DruckluftreglerLieferumfang Messgerät und Halterung .
- 1/8 " - 1" Regulador neumático suministra con Gauge y soporte .
- 1/8 " - 1" pneumatique régulateur fourni avec manomètre et support

Pneumatic Pressure Regulator



- Supplied with Gauge & Bracket
- Economic
- Locking Top
- Rugged and accurate
- 0-10 Bar

Description

Compressed air is subject to continuous variations and fluctuation in pipe line pressure caused by inconsistencies in consumption and by irregular operation of compressors. It is always necessary to regulate the air pressure in order to maintain it to the required level and set it to a more constant pressure.

Unit supplied with Bracket and Gauge



Description

Pneumatic Regulator

Pressure regulators enable the regulation, reduce and stabilise air pressure in the pneumatic circuit, adapting the pressure to the requirements of the equipment it's supplying.



Beschreibung

pneumatische Regler

Druckregler ermöglichen die Regulierung , Verringerung und Stabilisierung der Luftdruck in der pneumatischen Schaltung , die Anpassung des Drucks an die Anforderungen der Geräte ist es liefert .



Descripción

Regulador neumático

Los reguladores de presión permiten la regulación , reducir y estabilizar la presión de aire en el circuito neumático , la adaptación de la presión a los requisitos del equipo que está suministrando .







Descriptión

Régulateur pneumatique

Les régulateurs de pression permettent de réguler , réduire et stabiliser la pression d'air dans le circuit pneumatique , adapter la pression aux exigences de l' équipement, il est à fournir . .

Model	Port Size
FM-20-01-R	1/8"
FM-30-02-R	1.4"
FM-40-03-R	3/8"
FM-40-04-R	1/2"
FM-50-06-R	3/4"
FM-50-10-R	1"

-  VOLT Pneumatic Pressure Regulator
-  VOLT pneumatische Druckregler
-  VOLT regulador de presión neumática
-  VOLT pneumatique Régulateur de pression

Pneumatic Regulator

Regulator is for use on compressed air systems.

It is easy to adjust with a clear accurate gauge and has a lock-off feature. Screwed BSP.

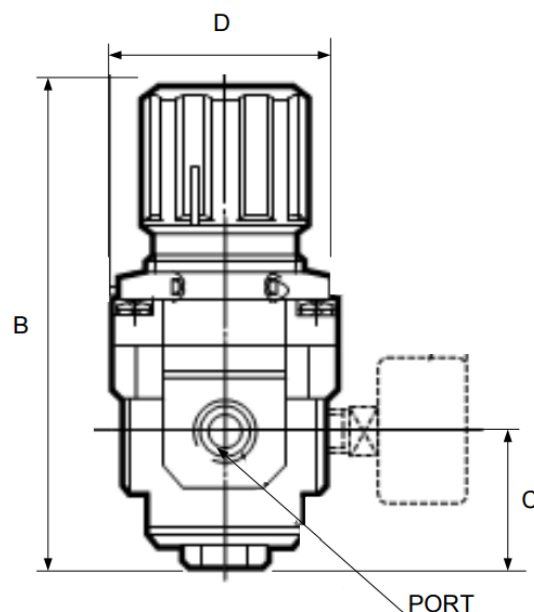

Regulator is supplied with bracket and gauge

SPECIFICATIONS	
Max. Supply Press.	220psi
Max. Operating Pressure	142psi
Ambient & Media Temp.	60°C
Regulating Range	5 - 120 PSI

Model	Port Size	B	D	C
FM-20-01-R	1/8"	90	50	26.5
FM-30-02-R	1.4"	113.5	53	31
FM-40-03-R	3/8"	125	64	36
FM-40-04-R	1/2"	125	64	36
FM-50-06-R	3/4"	140	64	46
FM-50-10-R	1"	140	64	46

Model	Port Size	Flow Rate L min	Gauge Port	Weight
FM-20-01-R	1/8"	500	1/8"	0.6
FM-30-02-R	1.4"	2500	1/8"	0.6
FM-40-03-R	3/8"	6000	1/4"	0.9
FM-40-04-R	1/2"	6000	1/4"	1.9
FM-50-06-R	3/4"	7000	1/4"	2.6
FM-50-10-R	1"	7000	1/4"	2.6